

General Specifications:

- High Flow for Maintaining Water Clarity
- 600 GPM, 4 Filter Unit (500 GPM @ 50 Hz)
- Power Requirements: 15HP, 460V, 3 PH, 60 Hz, 24.5A
- Power Requirements: 15HP, 380V, 3 PH, 50 Hz, 24.0A
- All Material - Stainless Steel
- System Operation: Negative Pressure
- Max Operating Temperature: 140 °F
- Empty Weight (Housing and Pump): 460#
- Weight Full of Water (Housing and Pump): 965#
- Two 25 Foot 3" Discharge Hoses with Diffusers
- Gravity Seated Pump in Pump Housing
- Four Tri Nuclear Filter Cartridges

		Tri Nuclear Corp. P.O. Box 1130, Ballston Lake, NY 12019			
Underwater Filter Unit UF-600					
Model No.	UF-600	Rev. Date	Rick Russell 07/21/14	Brochure Page 1 of 4	
Dwg.	TNC-003-02	Apv'd Date	James L. Warden 07/21/14		

UF-600OP "UF-600 OPERATING SYSTEM"

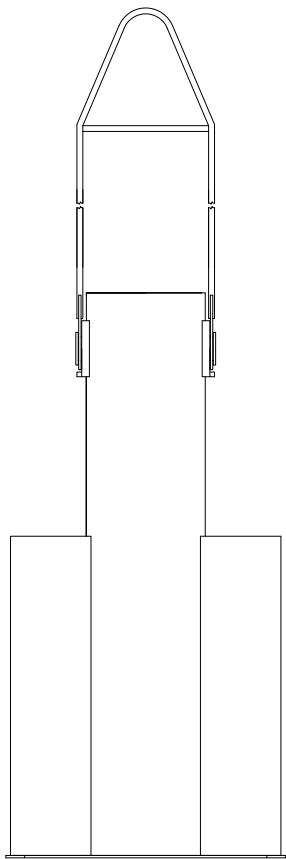

UF-600H Housing

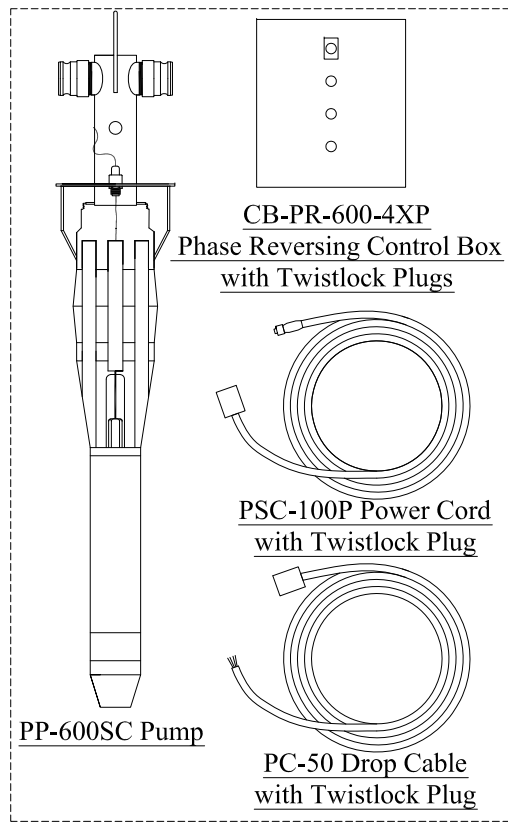

PP-600SC Pump

PP-600SC Pump

CB-PR-600-4XP
Phase Reversing Control Box
with Twistlock Plugs

PSC-100P Power Cord
with Twistlock Plug

PC-50 Drop Cable
with Twistlock Plug

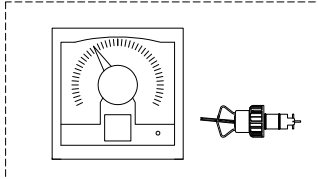

FM-600 Flow Meter Kit

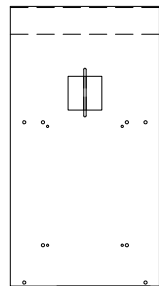

UT-10A Control Panel

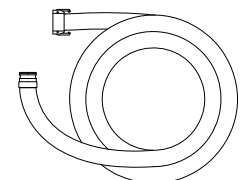

PH-3x25 Discharge Hose
Qty: 2

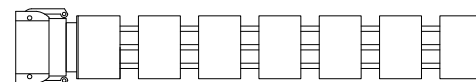

UT-8 Diffuser Pipe
Qty: 2

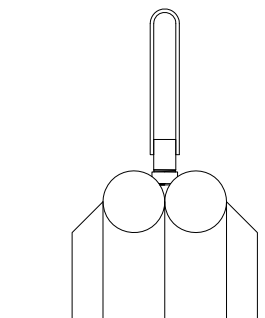

UT-3/6 Filter Storage Rack

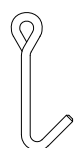

UT-14 Pump Lift Hook

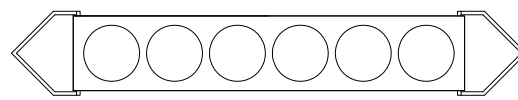

UT-3H Hanging Filter Storage Rack

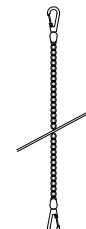

UT-15 Utility Chain
Qty: 2



UT-9 Rope Filter Lift Tool
Qty: 2

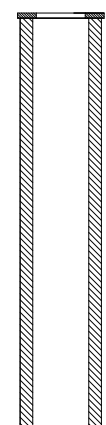

VCPH-*PE Filter Cartridge
NOTE: Not supplied with system.

NOTE:

All Items Shown come with the UF-600 "Complete System" in listed quantity except as noted.

		Tri Nuclear Corp. P.O. Box 1130, Ballston Lake, NY 12019			
UF-600 System Part Identification					
Model No.	UF-600	Dwg.	TNC-003-02	Rev.	D
					Page 2 of 4

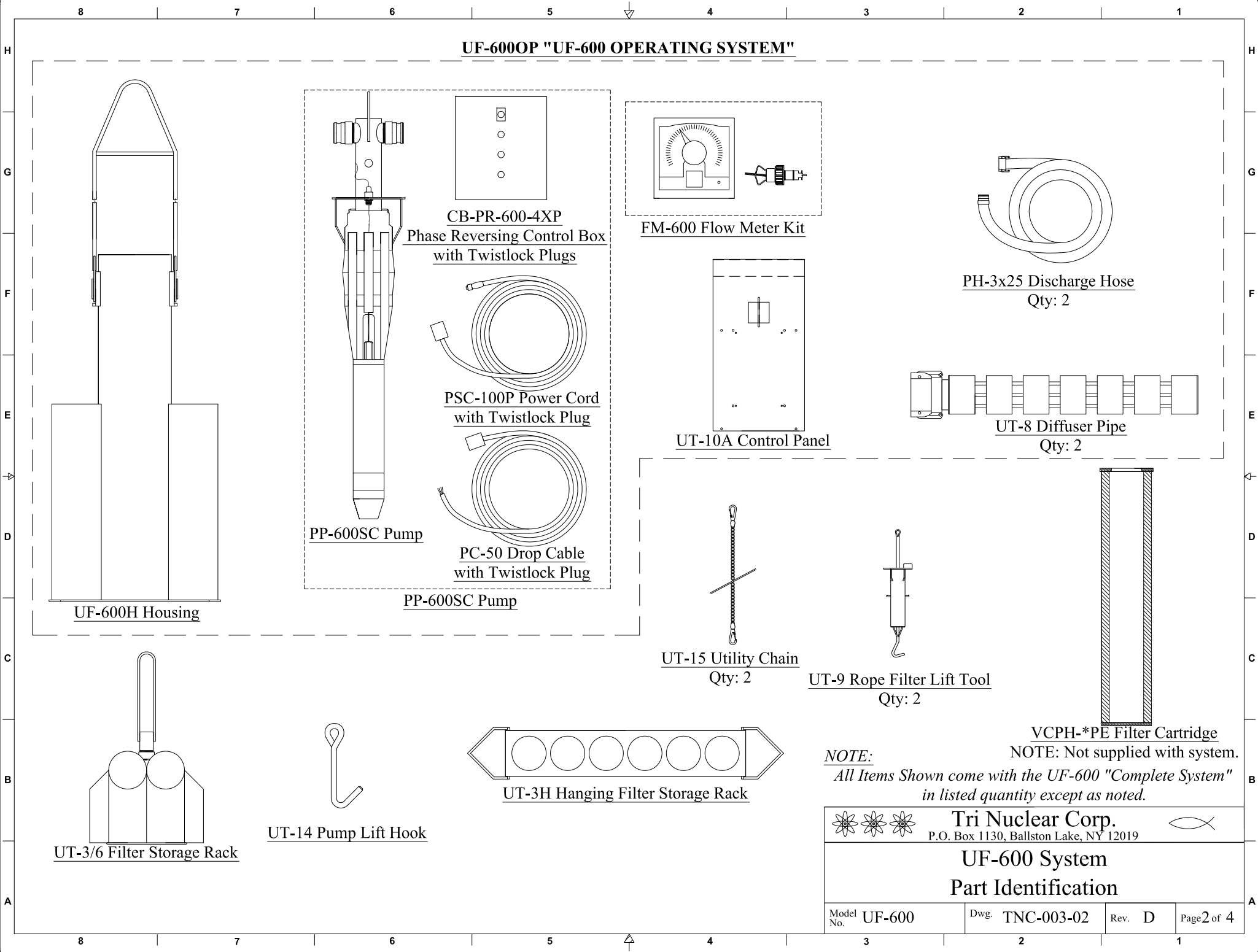

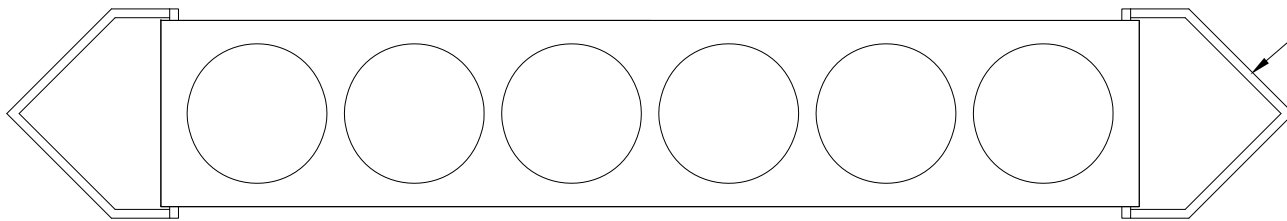

Swing Lift Bail

UT-3H Hanging Filter Storage Rack
 Holds (6) Tri Nuclear Filter Cartridges
 Dimensions: 42" x 8" x 4" (LWH)
 Weight: 13.5#

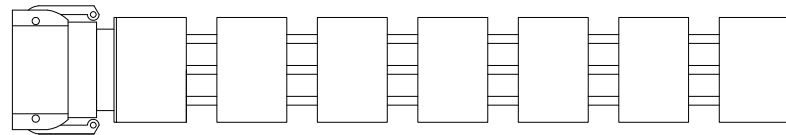

UT-8 Diffuser Pipe
 Attaches to 3" Discharge Hose (Typically PH-3x25)
 Dimensions: 3-1/2" Dia x 33-1/2" Lg.
 Weight: 15#

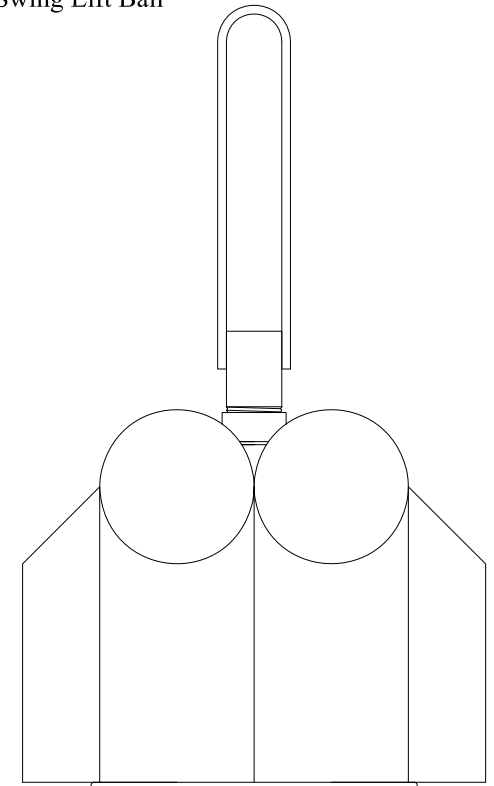

UT-3/6 Filter Storage Rack
 Holds (6) Tri Nuclear Filter Cartridges
 Dimensions: 20" Dia x 33" High
 Weight: 50#

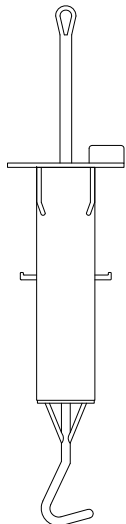

UT-9 Rope Filter Lift Tool
 Dimensions: 5" Dia x 24-3/4" Lg.
 Weight: 4.5#

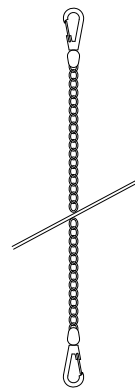

UT-15 Utility Chain
 Attaches to UT-5SP & UT-9
 Dimensions: 50' Lg.
 Weight: 2#

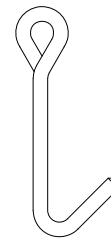

UT-14 Pump Lift Hook
 Dimensions: 4-1/2" x 5/8" x 8" (LWH)
 Weight: 1#

● All Material - Stainless Steel

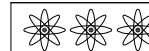

Tri Nuclear Corp.
 P.O. Box 1130, Ballston Lake, NY 12019



UF-600
Accessory Tooling



Model No. **UF-600**

Dwg. **TNC-003-02**

Rev. **D**

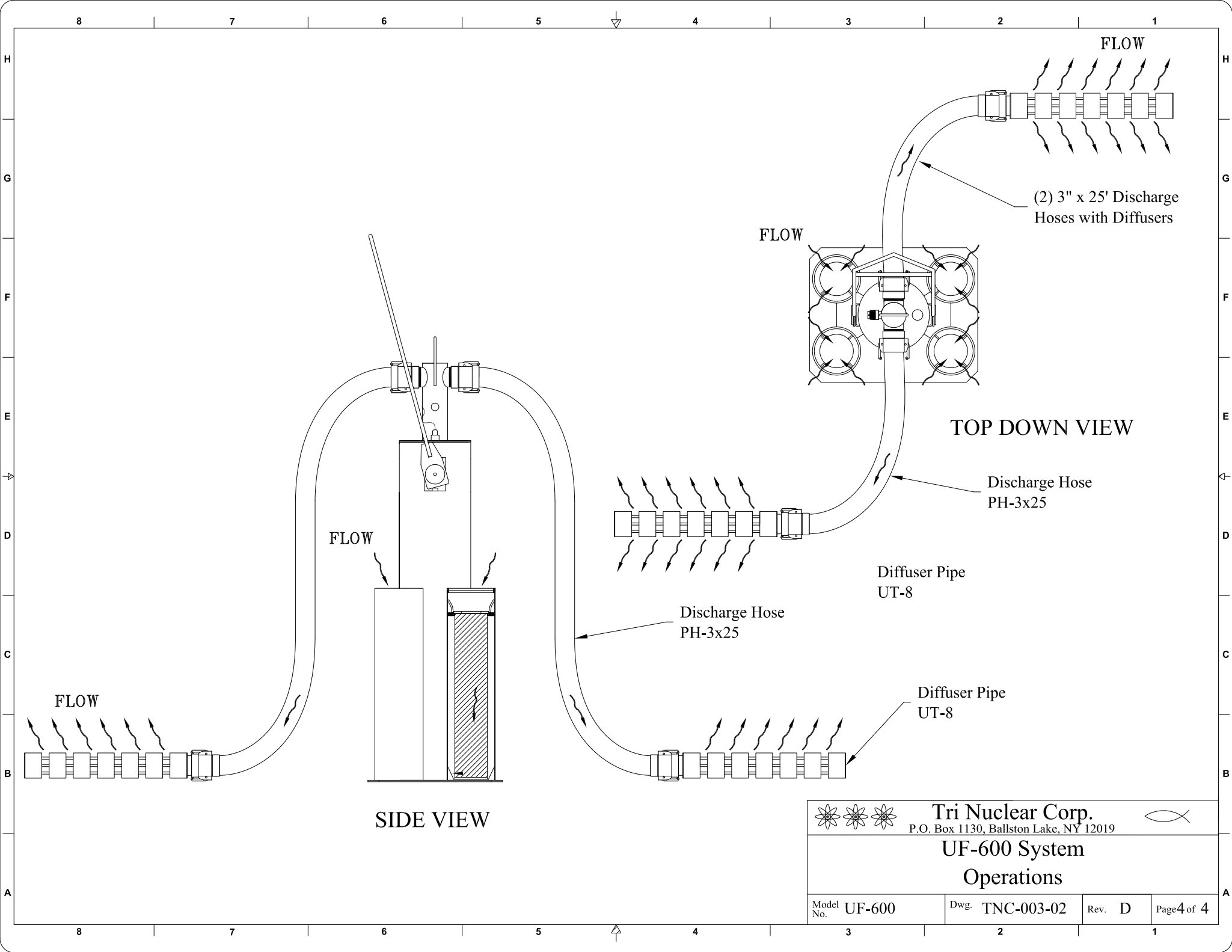
Page **3** of **4**



 Tri Nuclear Corp. P.O. Box 1130, Ballston Lake, NY 12019			
UF-600 System Operations			
Model No.	UF-600	Dwg.	TNC-003-02
		Rev.	D
			Page 4 of 4