

General Specifications:

- High Flow for Vacuuming & Maintaining Water Clarity
- 600 GPM, 4 Filter Unit (500 GPM @ 50 Hz)
- Power Requirements: 15HP, 460V, 3 PH, 60 Hz, 24.5A
- Power Requirements: 15HP, 380V, 3 PH, 50 Hz, 24.0A
- All Material - Stainless Steel
- System Operation: Negative Pressure
- Max Operating Temperature: 140 °F
- Empty Weight (Housing and Pump): 550#
- Weight Full of Water (Housing and Pump): 1,025#
- Two 25 Foot 3" Discharge Hoses with Diffusers
- Two 50 Foot 2-1/2" Suction Hoses with Standoffs
- Gravity Seated Pump in Pump Housing
- Four Tri Nuclear Filter Cartridges

		Tri Nuclear Corp. P.O. Box 1130, Ballston Lake, NY 12019			
Underwater Filter Vacuum Unit UFV-600					
Model No.	UFV-600	Rev. Date	Rick Russell 07/21/14	Brochure	
Dwg.	TNC-004-02	Apv'd Date	James L. Warden 07/21/14	Rev. C	Page 1 of 4

UFV-600OP "UFV-600 OPERATING SYSTEM"

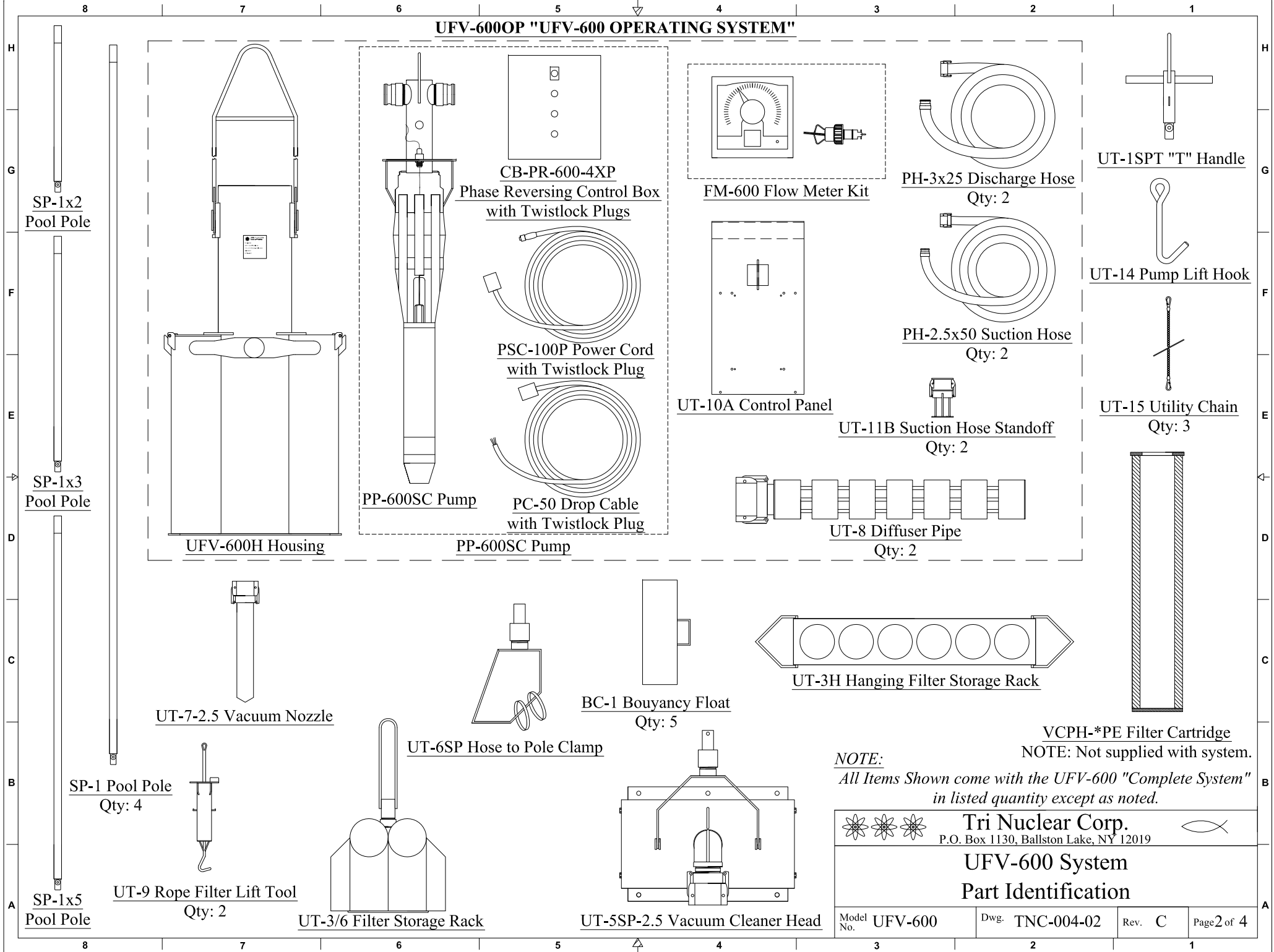

NOTE:
All Items Shown come with the UFV-600 "Complete System" in listed quantity except as noted.

VCPH-*PE Filter Cartridge
 NOTE: Not supplied with system.

		Tri Nuclear Corp. P.O. Box 1130, Ballston Lake, NY 12019			
UFV-600 System Part Identification					
Model No.	UFV-600	Dwg.	TNC-004-02	Rev.	C
					Page 2 of 4

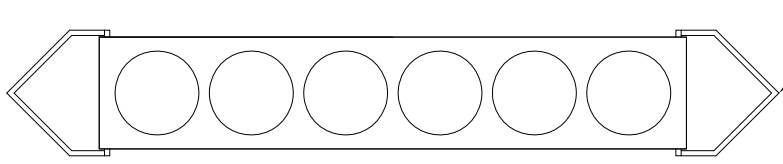

UT-3H Hanging Filter Storage Rack
Holds (6) Tri Nuclear Filter Cartridges
Dimensions: 42" x 8" x 4" (LWH)
Weight: 13.5#

Swing Lift Bail

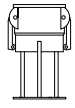

UT-11B Suction Hose Standoff
Attaches to 2-1/2" Suction Hose (Typically PH-2.5x50)
Dimensions: 3" Dia x 8" Lg.
Weight: 3.5#

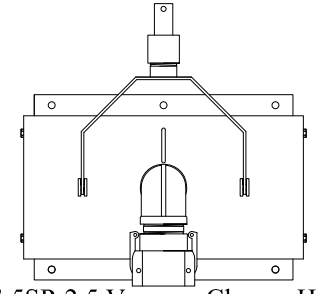

UT-5SP-2.5 Vacuum Cleaner Head
Attaches to 2-1/2" Suction Hose (Typically PH-2.5x50)
Dimensions: 20" x 10" x 8"
Weight: 20#
Polypro Camlock Fitting

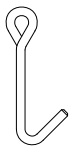

UT-14 Pump Lift Hook
Dimensions: 4-1/2" x 5/8" x 8"
Weight: 1#

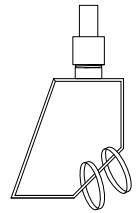

UT-6SP Hose to Pole Clamp
Dimensions: 13-3/4" x 8" x 2"
Weight: 2.5#

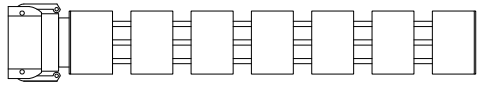

UT-8 Diffuser Pipe
Attaches to 3" Discharge Hose (Typically PH-3x25)
Dimensions: 3-1/2" Dia x 33-1/2" Lg.
Weight: 15#

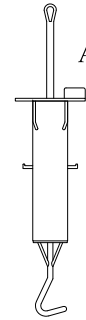

UT-9 Rope Filter Lift Tool
Dimensions: 5" Dia x 24-3/4" Lg.
Weight: 4.5#

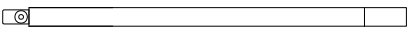

SP-1x2 Pool Pole
Dimensions: 1" Dia x 2' Lg.
Weight: 2#

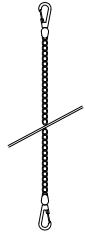

UT-15 Utility Chain
Attaches to UT-5SP & UT-9
Dimensions: 50' Lg.
Weight: 2#

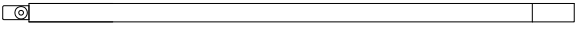

SP-1x3 Pool Pole
Dimensions: 1" Dia x 3' Lg.
Weight: 3#

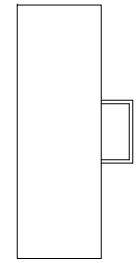

BC-1 Bouyancy Float
Dimensions: 6" Dia x 12" Lg.
Weight: 8.5#

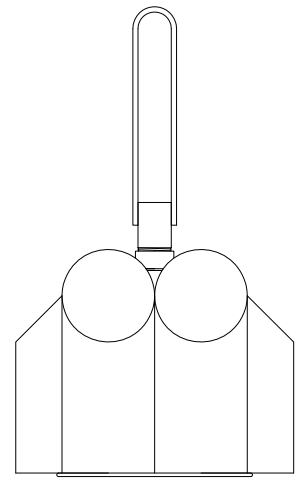

UT-3/6 Filter Storage Rack
Holds (6) Tri Nuclear Filter Cartridges
Dimensions: 20" Dia x 33" High
Weight: 50#

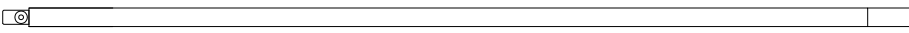

SP-1x5 Pool Pole
Dimensions: 1" Dia x 5' Lg.
Weight: 5#

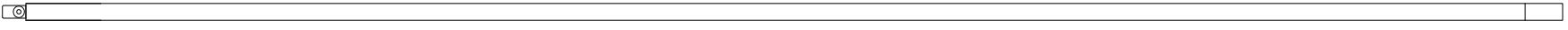

SP-1 Pool Pole
Dimensions: 1" Dia x 10' Lg.
Weight: 10#

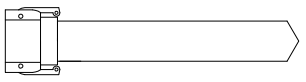

UT-7-2.5 Vacuum Nozzle
Attaches to 2-1/2" Suction Hose (Typically PH-2.5x50)
Dimensions: 3" Dia x 20" Lg.
Weight: 7.5#

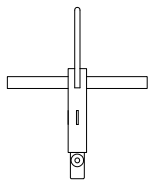

UT-1SPT "T" Handle
Dimensions: 10" x 10" x 1"
Weight: 2#

● All Material - Stainless Steel

		Tri Nuclear Corp. P.O. Box 1130, Ballston Lake, NY 12019			
UFV-600 Accessory Tooling					
Model No.	UFV-600	Dwg.	TNC-004-02	Rev.	C
			Page	3 of 4	

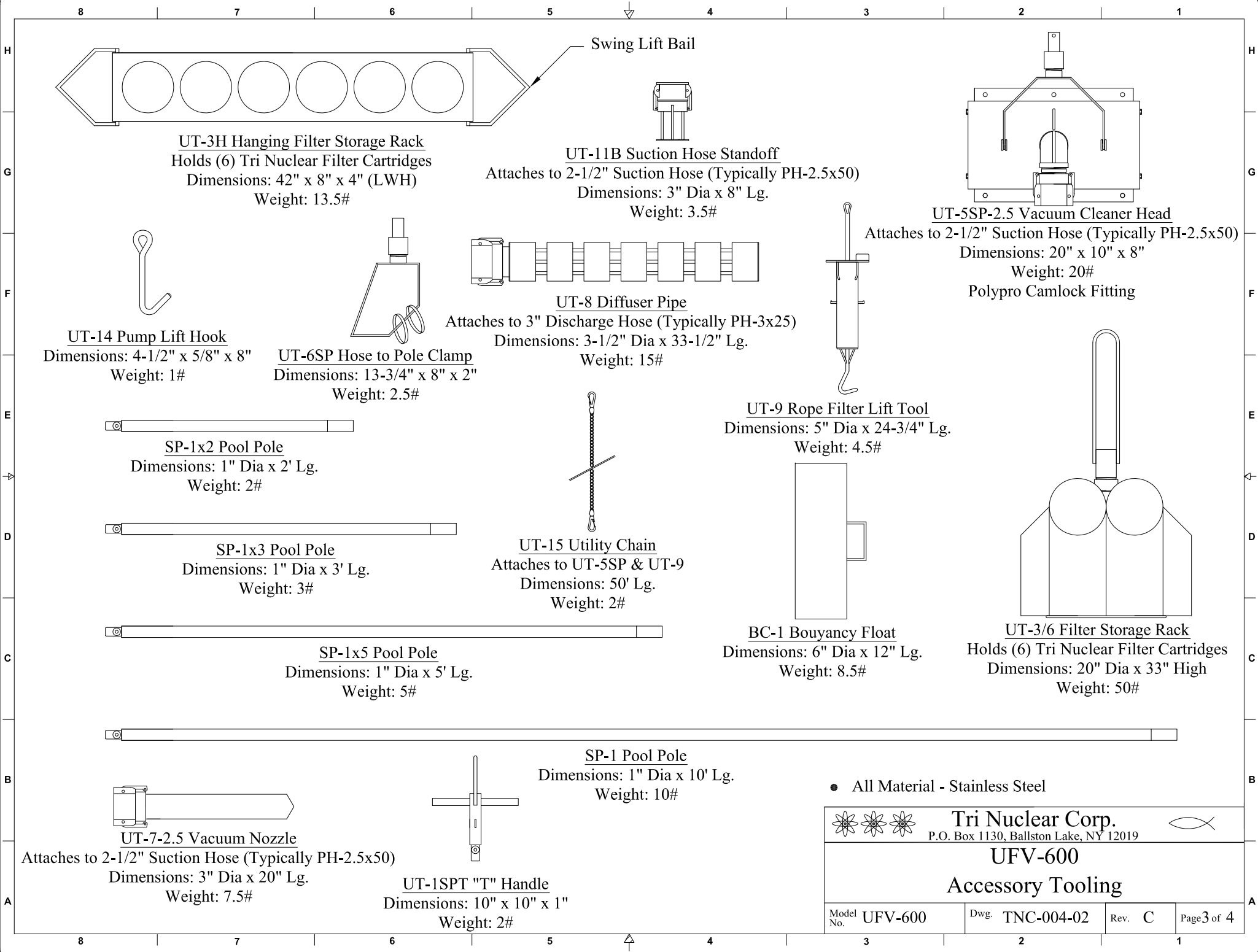

VACUUMING OPERATIONS

NOTE: Each Suction Hose is tied to a single bank of 2 filters.
 Vacuuming with one Suction Hose can cause an imbalance in filter loading between the two banks of filters.

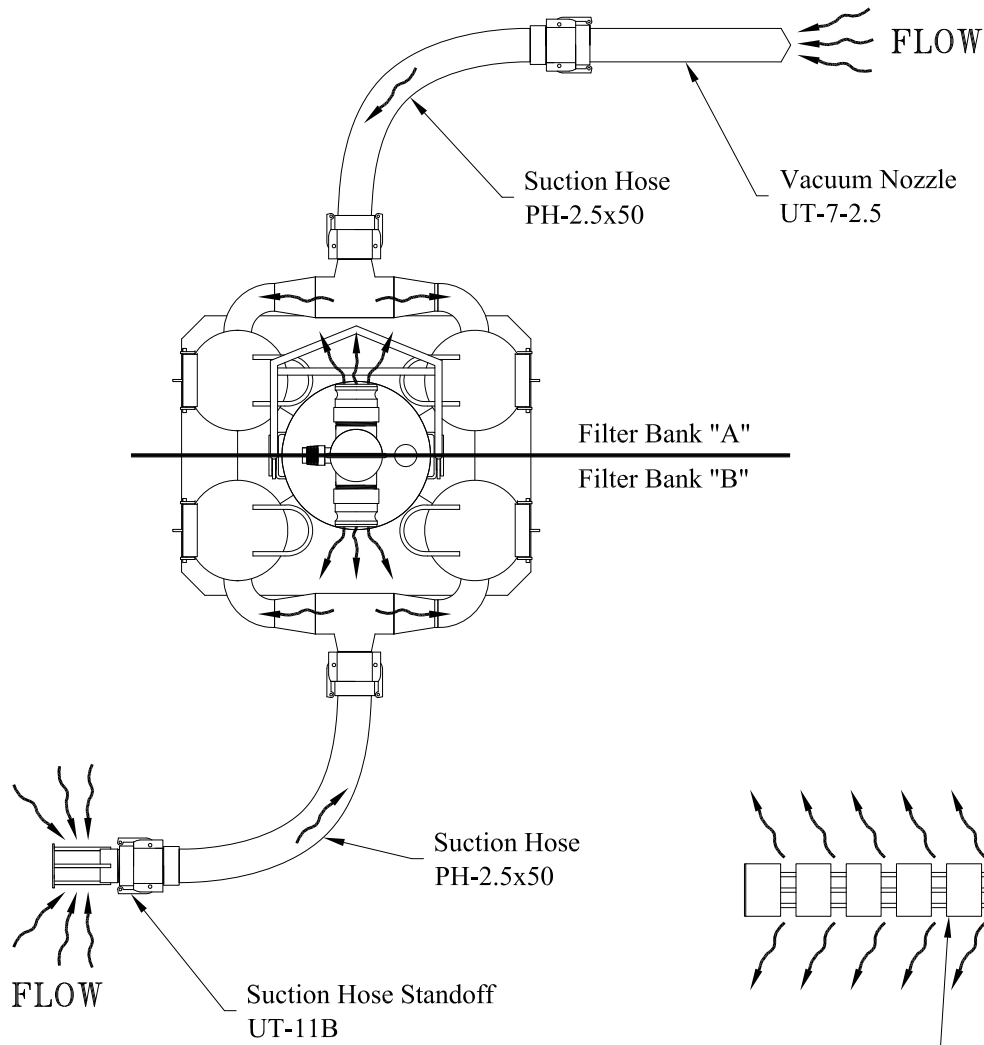

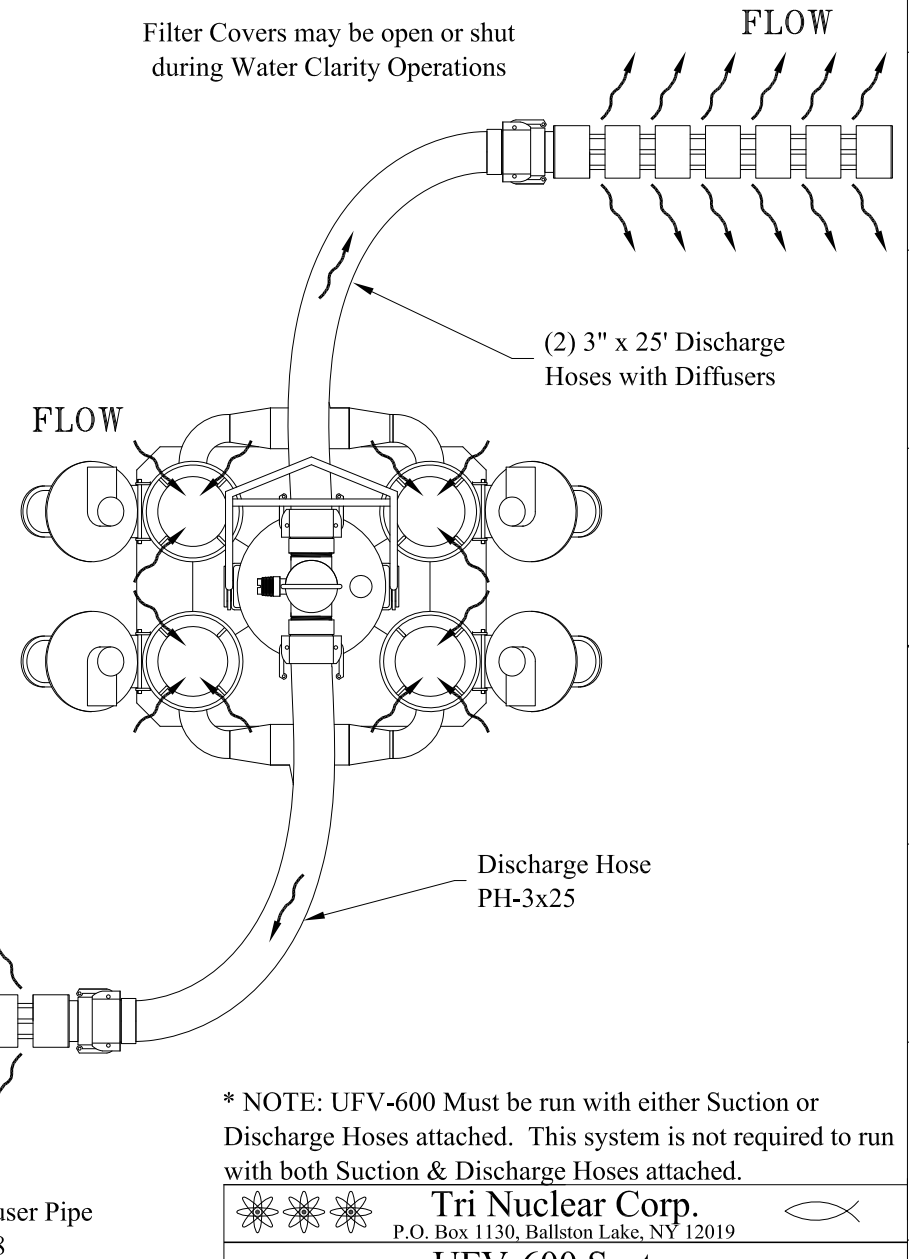

WATER CLARITY OPERATIONS

Filter Covers may be open or shut during Water Clarity Operations

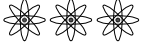

* NOTE: UFV-600 Must be run with either Suction or Discharge Hoses attached. This system is not required to run with both Suction & Discharge Hoses attached.

 Tri Nuclear Corp. P.O. Box 1130, Ballston Lake, NY 12019		
UFV-600 System Modes of Operation		
Model No. UFV-600	Dwg. TNC-004-02	Rev. C
Page 4 of 4		