

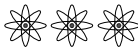

General Specifications:

- Designed for Vacuuming & Maintaining Water Clarity
- 260 GPM, 2 Filter Unit
- Power Requirements: 5HP, 460V, 3 PH, 60 Hz, 9.9A
- All Material - Stainless Steel
- System Operation: Negative Pressure
- Max Operating Temperature: 140 °F
- Empty Weight (Housing and Pump): 255 lb.
- Weight Full of Water (Housing and Pump): 485 lb.
- Two 50 Foot 2\"/>

 Tri Nuclear Corp. P.O. Box 1130, Ballston Lake, NY 12019			
Underwater Filter Vacuum Unit UFV-260			
Model No. UFV-260	Rev. Date Rick Russell 08/25/17	Brochure	
Dwg. TNC-002-02	Apv'd Date James L. Warden 08/30/17	Rev. D	Page 1 of 4

UFV-260OP "UFV-260 OPERATING SYSTEM"

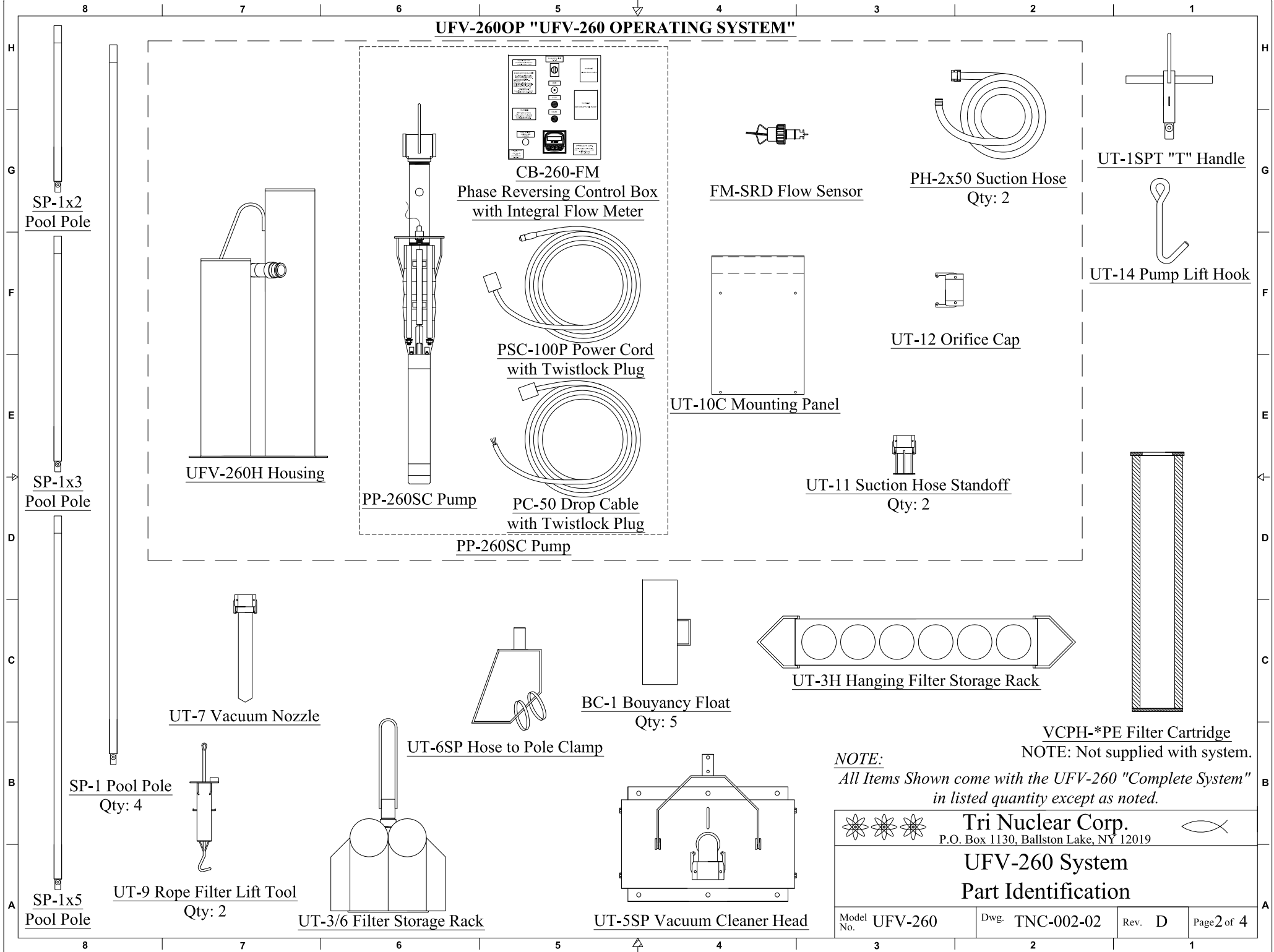

NOTE:
All Items Shown come with the UFV-260 "Complete System" in listed quantity except as noted.

Tri Nuclear Corp. P.O. Box 1130, Ballston Lake, NY 12019						
UFV-260 System Part Identification						
Model No.	UFV-260	Dwg.	TNC-002-02	Rev.	D	Page 2 of 4

8 7 6 5 4 3 2 1

H

H

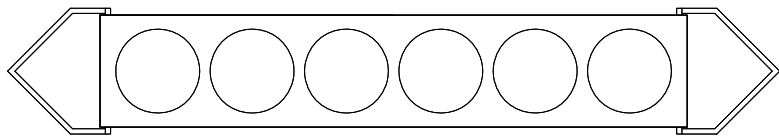

UT-3H Hanging Filter Storage Rack
Holds (6) Tri Nuclear Filter Cartridges
Dimensions: 42" x 8" x 4" (LWH)
Weight: 13.5#

Swing Lift Bail

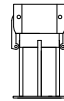

UT-11 Suction Hose Standoff
Attaches to 2" Suction Hose (Typically PH-2x50)
Dimensions: 3" Dia x 8" Lg.
Weight: 2#

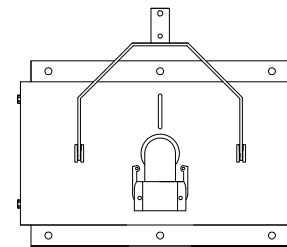

UT-5SP Vacuum Cleaner Head
Attaches to 2" Suction Hose (Typically PH-2x50)
Dimensions: 20" x 10" x 8"
Weight: 18.5#
Polypro Camlock Fitting

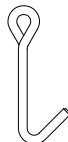

UT-14 Pump Lift Hook
Dimensions: 4-1/2" x 5/8" x 8"
Weight: 1#

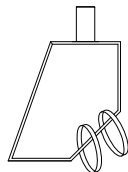

UT-6SP Hose to Pole Clamp
Dimensions: 13-3/4" x 8" x 2"
Weight: 2#

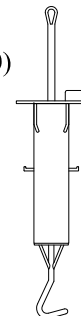

UT-9 Rope Filter Lift Tool
Dimensions: 5" Dia x 24-3/4" Lg.
Weight: 4.5#



SP-1x2 Pool Pole
Dimensions: 1" Dia x 2' Lg.
Weight: 2.5#

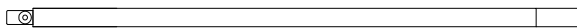

SP-1x3 Pool Pole
Dimensions: 1" Dia x 3' Lg.
Weight: 3#

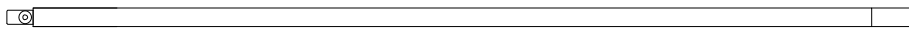

SP-1x5 Pool Pole
Dimensions: 1" Dia x 5' Lg.
Weight: 5#

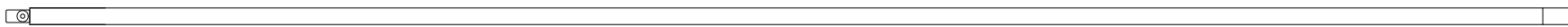

SP-1 Pool Pole
Dimensions: 1" Dia x 10' Lg.
Weight: 9#

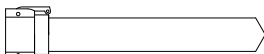

UT-7 Vacuum Nozzle
Attaches to 2" Suction Hose (Typically PH-2x50)
Dimensions: 2" Dia x 18" Lg.
Weight: 4#

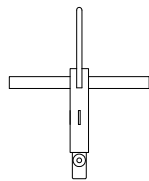

UT-1SPT "T" Handle
Dimensions: 10" x 10" x 1"
Weight: 2#



UT-12 Orifice Cap
Dimensions: 3" x 3" x 4" (LWH)
Weight: 0.5#
Polypro Camlock Fitting

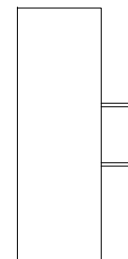

BC-1 Bouyancy Float
Dimensions: 6" Dia x 12" Lg.
Weight: 8.5#

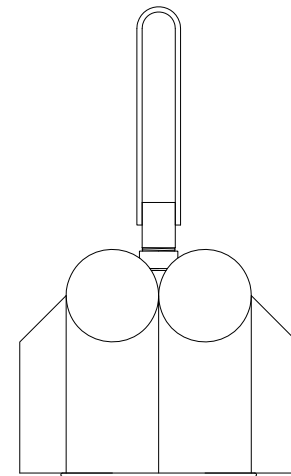

UT-3/6 Filter Storage Rack
Holds (6) Tri Nuclear Filter Cartridges
Dimensions: 20" Dia x 33" High
Weight: 50#

• All Material - Stainless Steel except as noted.

 Tri Nuclear Corp. P.O. Box 1130, Ballston Lake, NY 12019			
UFV-260 Accessory Tooling			
Model No.	UFV-260	Dwg.	TNC-002-02
Rev.	D	Page	3 of 4

8 7 6 5 4 3 2 1

A

A



WATER CLARITY OPERATIONS

(Dual Hose Operation)

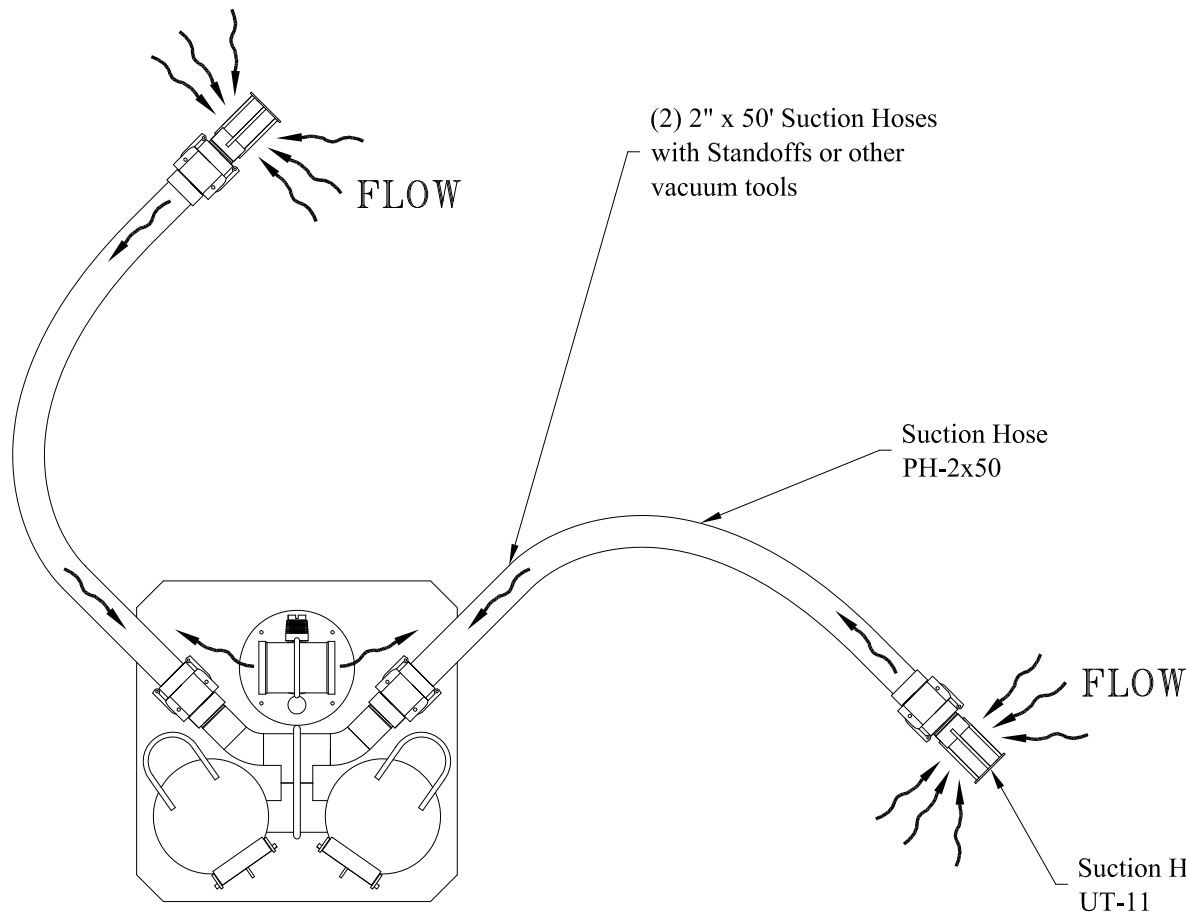

VACUUMING OPERATIONS

(Single Hose Operation)

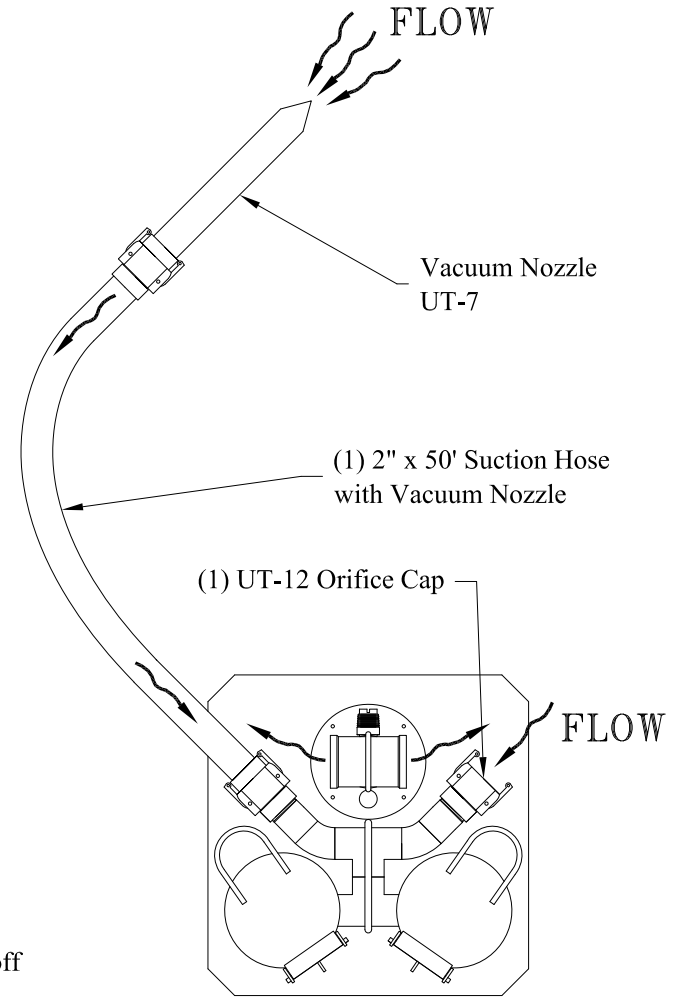

* NOTE: UFV-260 Must be run with at least one Suction Hose attached.

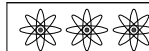

Tri Nuclear Corp.
P.O. Box 1130, Ballston Lake, NY 12019



UFV-260 System
Modes of Operation

Model No.	UFV-260	Dwg.	TNC-002-02	Rev.	D	Page	4 of 4
-----------	---------	------	------------	------	---	------	--------