



**General Specifications:**

- High Flow for Maintaining Water Clarity
- 600 GPM, 4 Filter Unit
- Power Requirements: 15HP, 460V, 3 PH, 60 Hz, 24.5A
- All Material - Stainless Steel
- System Operation: Negative Pressure
- Max Operating Temperature: 140 °F
- Empty Weight (Housing and Pump): 515 lb.
- Weight Full of Water (Housing and Pump): 1,020 lb.
- Two 25 Foot 3" Discharge Hoses with Diffusers
- Gravity Seated Pump in Pump Housing
- Four Tri Nuclear Filter Cartridges

 <b>Tri Nuclear Corp.</b> P.O. Box 1130, Ballston Lake, NY 12019		
<b>Underwater Filter Unit</b> <b>UF-600</b>		
Model No. <b>UF-600</b>	Rev. Date <b>Rick Russell 08/25/17</b>	<b>Brochure</b>
Dwg. <b>TNC-003-02</b>	Apv'd Date <b>James L. Warden 08/30/17</b>	Rev. <b>F</b>   Page 1 of 4

**UF-600OP "UF-600 OPERATING SYSTEM"**

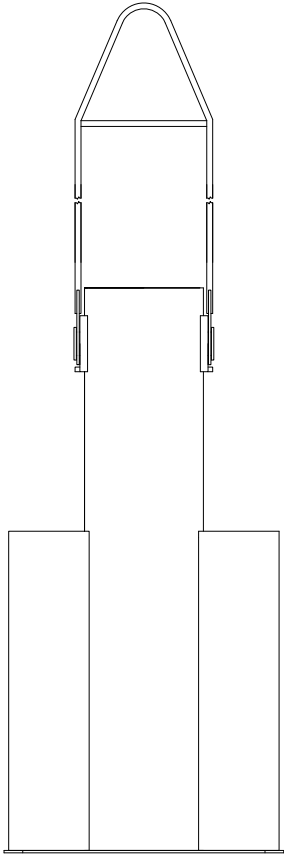

UF-600H Housing

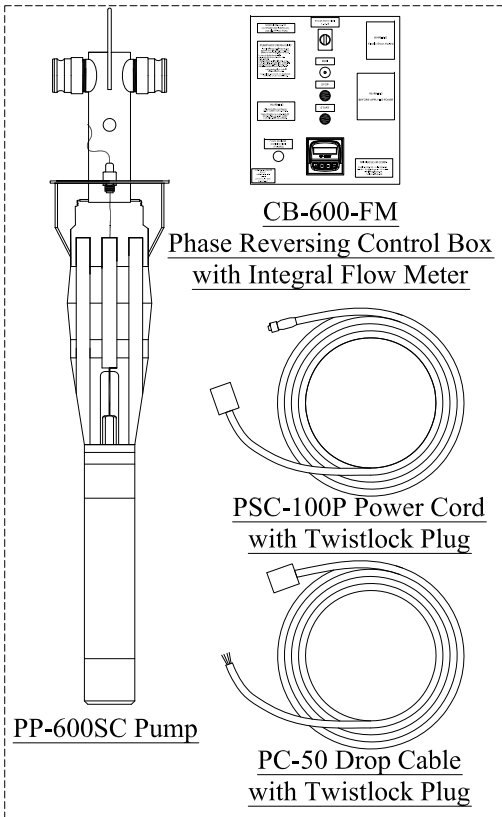

PP-600SC Pump

CB-600-FM  
Phase Reversing Control Box  
with Integral Flow Meter

PSC-100P Power Cord  
with Twistlock Plug

PC-50 Drop Cable  
with Twistlock Plug

PP-600SC Pump



FM-SRD Flow Sensor

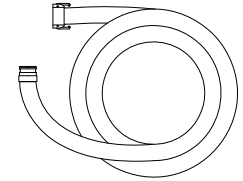

PH-3x25 Discharge Hose  
Qty: 2

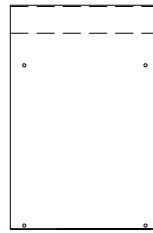

UT-10C Mounting Panel

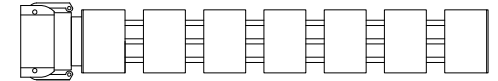

UT-8 Diffuser Pipe  
Qty: 2

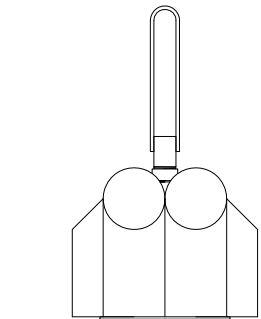

UT-3/6 Filter Storage Rack

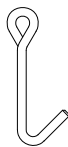

UT-14 Pump Lift Hook

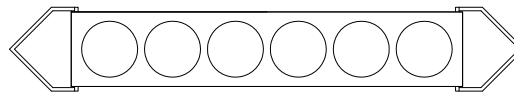

UT-3H Hanging Filter Storage Rack



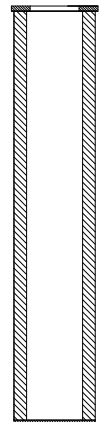

UT-9 Rope Filter Lift Tool  
Qty: 2



VCPH-\*PE Filter Cartridge  
NOTE: Not supplied with system.

**NOTE:**

*All Items Shown come with the UF-600 "Complete System" in listed quantity except as noted.*

		<b>Tri Nuclear Corp.</b> P.O. Box 1130, Ballston Lake, NY 12019			
<b>UF-600 System Part Identification</b>					
Model No.	UF-600	Dwg.	TNC-003-02	Rev.	F
					Page 2 of 4

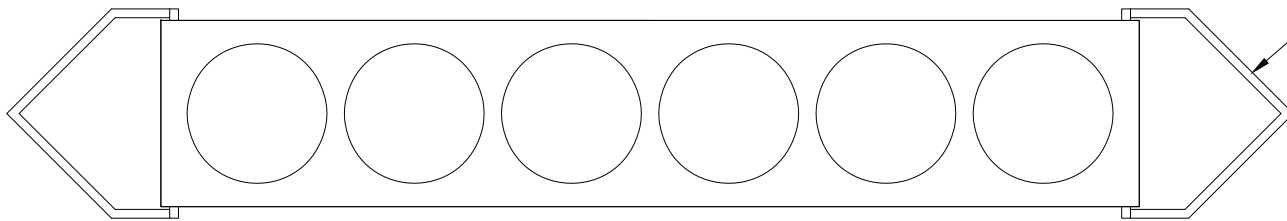

Swing Lift Bail

**UT-3H Hanging Filter Storage Rack**  
 Holds (6) Tri Nuclear Filter Cartridges  
 Dimensions: 42" x 8" x 4" (LWH)  
 Weight: 13.5#

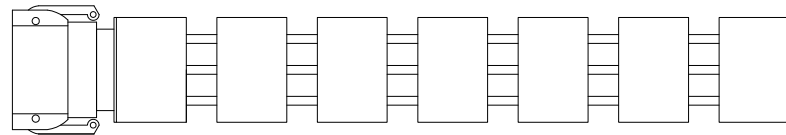

**UT-8 Diffuser Pipe**  
 Attaches to 3" Discharge Hose (Typically PH-3x25)  
 Dimensions: 3-1/2" Dia x 33-1/2" Lg.  
 Weight: 15#

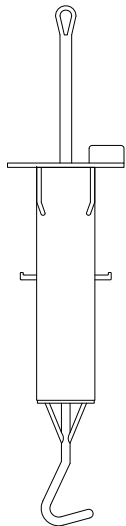

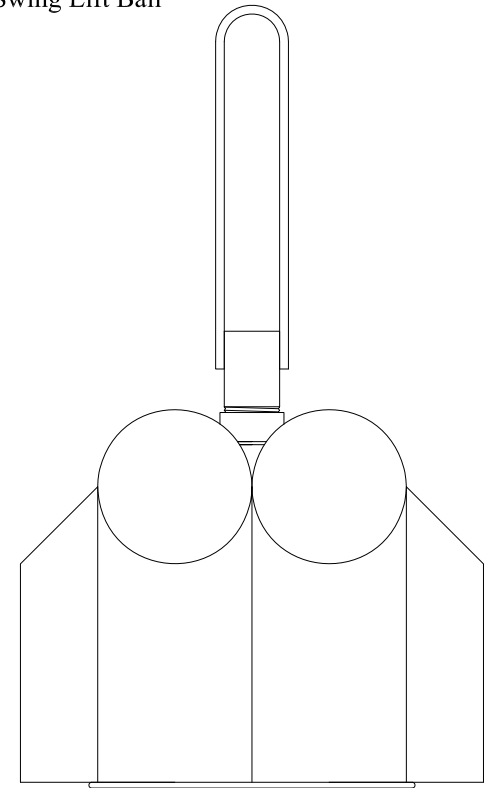

**UT-9 Rope Filter Lift Tool**  
 Dimensions: 5" Dia x 24-3/4" Lg.  
 Weight: 4.5#



**UT-3/6 Filter Storage Rack**  
 Holds (6) Tri Nuclear Filter Cartridges  
 Dimensions: 20" Dia x 33" High  
 Weight: 50#

**UT-14 Pump Lift Hook**  
 Dimensions: 4-1/2" x 5/8" x 8" (LWH)  
 Weight: 1#

● All Material - Stainless Steel

 <b>Tri Nuclear Corp.</b> P.O. Box 1130, Ballston Lake, NY 12019			
<b>UF-600</b> <b>Accessory Tooling</b>			
Model No.	UF-600	Dwg.	TNC-003-02
		Rev.	F
			Page 3 of 4

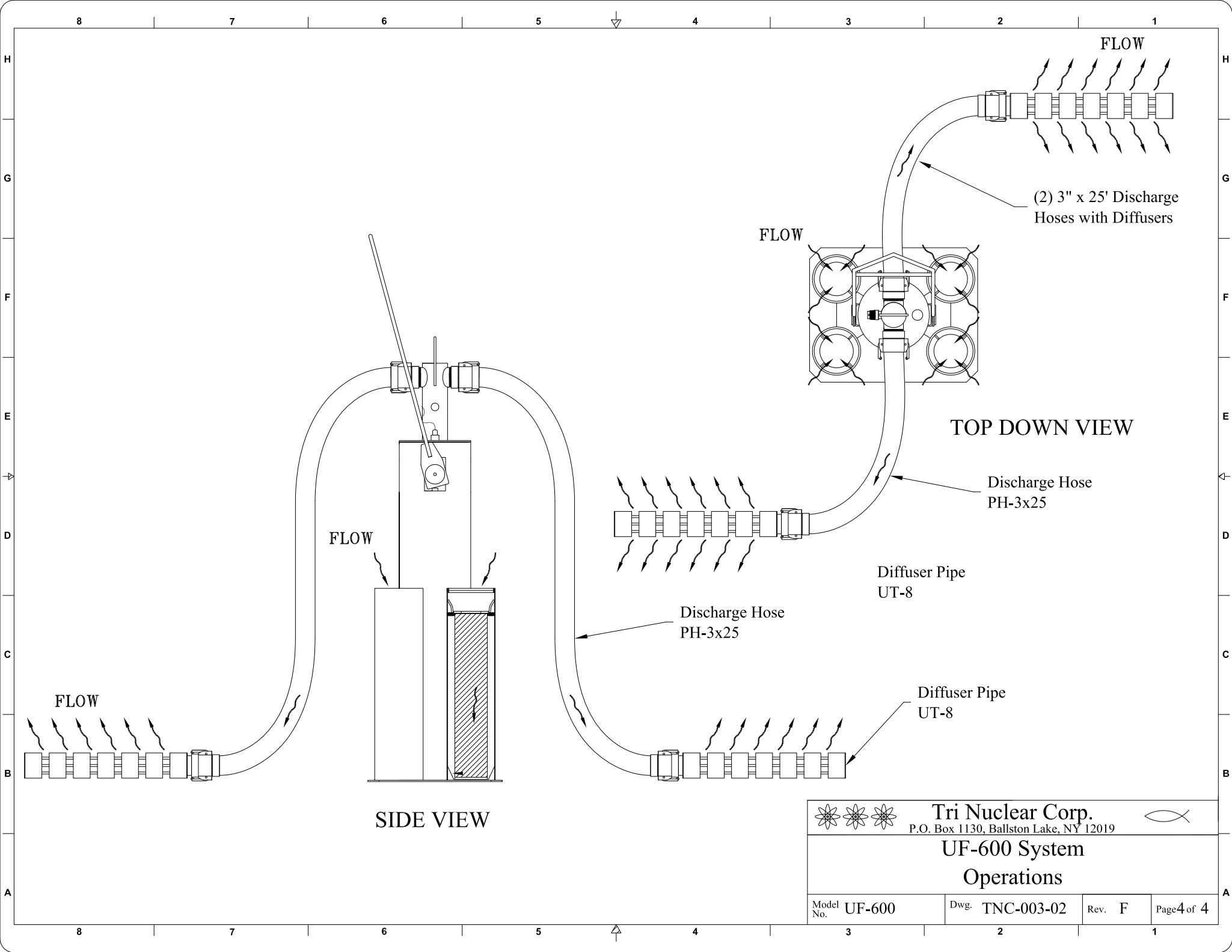

FLOW

FLOW

FLOW

FLOW

**SIDE VIEW**

**TOP DOWN VIEW**

(2) 3" x 25' Discharge Hoses with Diffusers

Discharge Hose PH-3x25

Diffuser Pipe UT-8

Discharge Hose PH-3x25

Diffuser Pipe UT-8

		<b>Tri Nuclear Corp.</b> P.O. Box 1130, Ballston Lake, NY 12019			
<b>UF-600 System Operations</b>					
Model No.	UF-600	Dwg.	TNC-003-02	Rev.	F
				Page	4 of 4