

General Specifications:

- Vessel Design per A.S.M.E. Boiler & Pressure Vessel Code, Section VIII, Div I. (Not Code Stamped)
- Lifting Certified per NUREG-0612 / ANSI N14.6
- Designed to be Sluiced In/Out while Submerged in Pool.
- All Material: 304L Stainless Steel
- Resin Capacity: 10 Cu. Ft.
- Power Requirements: 1-1/2HP, 460V, 3 PH, 60 Hz, 3.7A
- Design Flow Rate: 40 GPM
- Design Pressure: 50 PSIG
- Vessel Empty/Dry with Pump: 250 lbs.
- Vessel Full of Resin/Water with Pump: 1,100 lbs.

Tri Nuclear Corp. P.O. Box 1130, Ballston Lake, NY 12019		
Underwater Demineralizer 30" OD, 40 GPM, 10 CU. FT. Capacity		
Model No. UD-30A	Rev Date Rick Russell 08/25/17	Brochure
Dwg. TNC-011-02	Apv'd Date James L. Warden 08/30/17	Rev. D Page 1 of 3

UD-30A-Inlet Inlet Screen

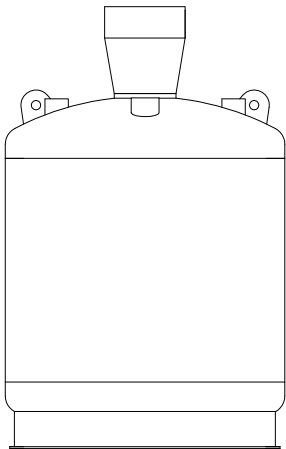
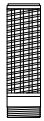

UD-30A-V Vessel

UD-30A-V Vessel

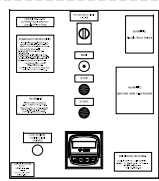

CB-40-FM
Phase Reversing Control Box
with Integral Flow Meter

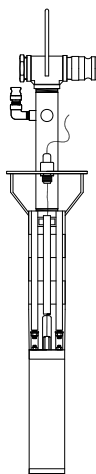

PP-40SC Pump

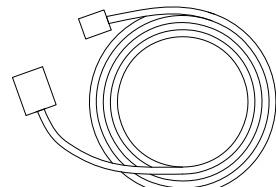

PSC-100P Power Cord
with Twistlock Plug

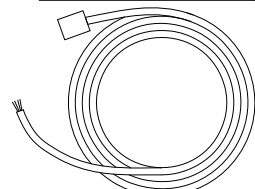

PC-50 Drop Cable
with Twistlock Plug

PP-100SC Pump

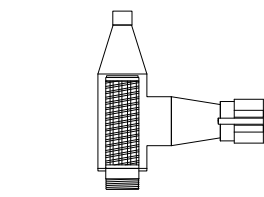

SHCK-SSVA-2x2
Safety Screen Vent Assembly

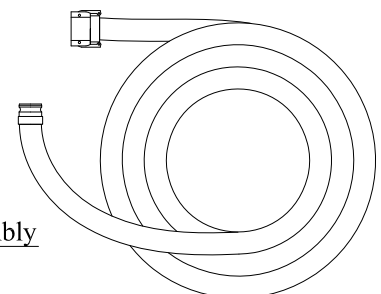

PH-2x50 Suction Hose

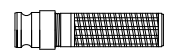

SHCK-JS-2x6
Johnson Screen Strainer

SHCK-UD-30A Suction Hose Conversion Kit



FM-SRD Flow Sensor

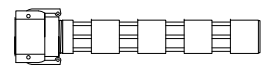

UT-8A 2" Diffuser Pipe

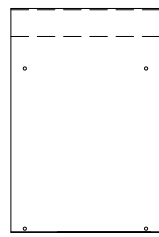

UT-10C Mounting Panel

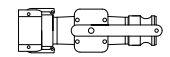

BV-1.5SS-MxF
Sluice Isolation Valve
Qty: 2

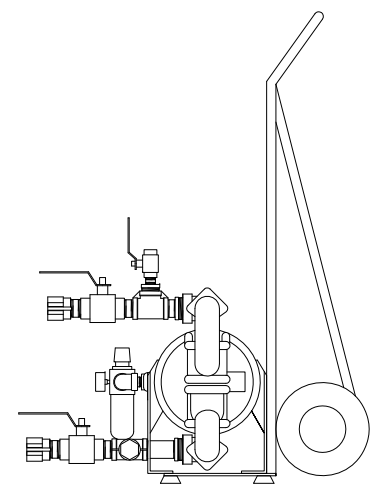

AP-65 Sluice Pump

NOTE: Not supplied with system.

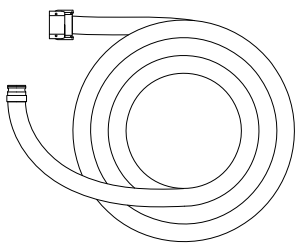

FPS-1.5x50 Sluice Hose
Qty: 2

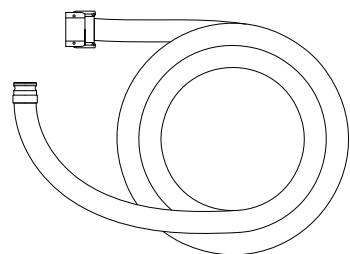

PH-2x25 Discharge Hose

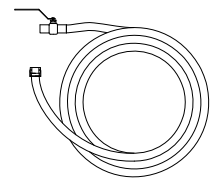

SH-.5x100 Sample Hose

NOTE:

*All Items Shown come with the UD-30A in listed quantity
except as noted.*

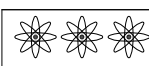

Tri Nuclear Corp.

P.O. Box 1130, Ballston Lake, NY 12019



UD-30A System Modes of Operation

Model No. UD-30A

Dwg. TNC-011-02

Rev. D

Page 2 of 3

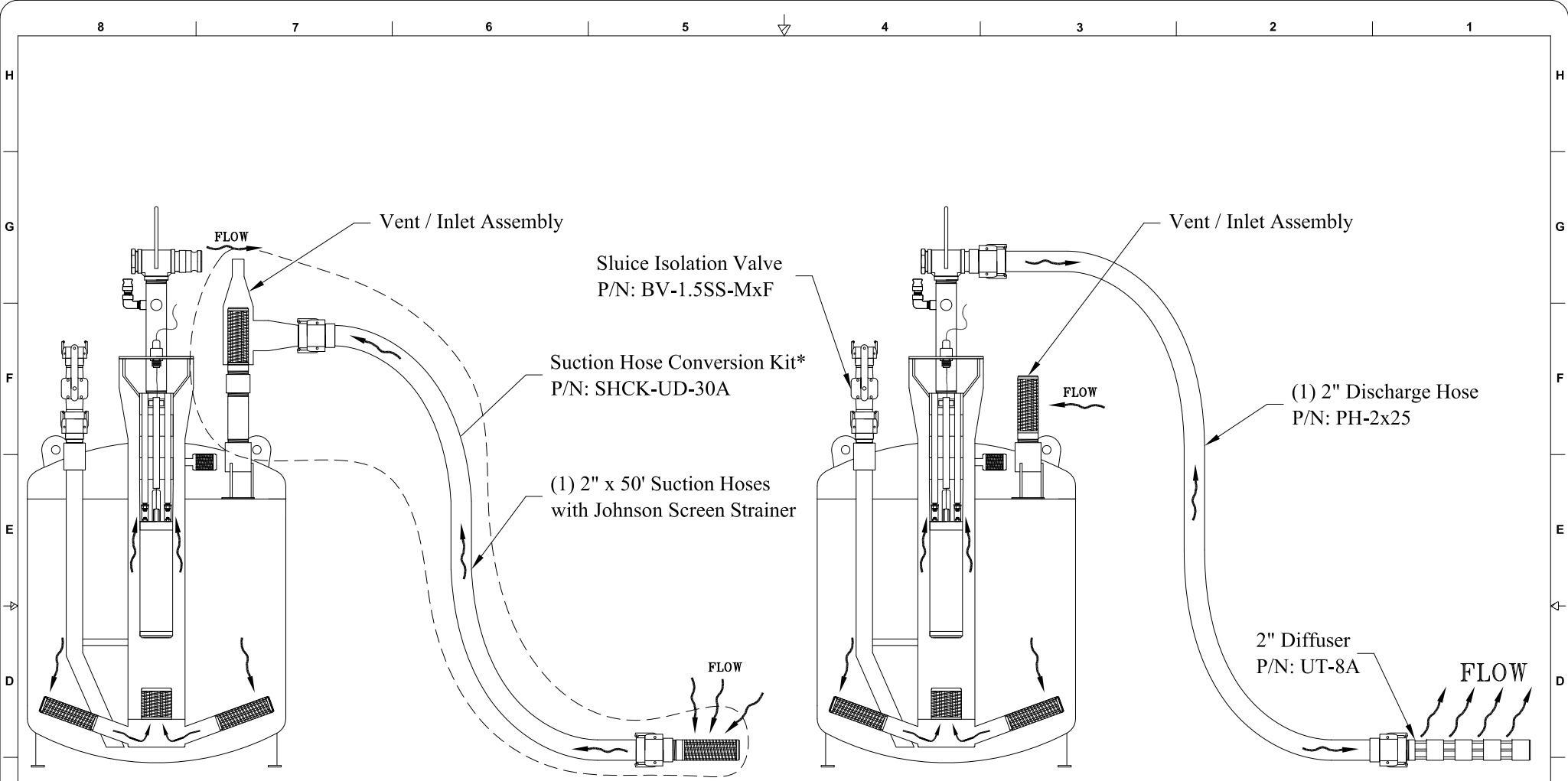

**"OPTIONAL"
SUCTION HOSE OPERATIONS**

Single Suction Hose attached to Vessel Inlet. No Hose attached to discharge of pump.

**"TYPICAL"
DISCHARGE HOSE OPERATIONS**

NOTE: UD-30A to be run with either Suction or Discharge Hoses attached for efficient cross-circulation. This system is not required to run with both Suction & Discharge Hoses.

***SHCK-UD-30A Includes:**

- (1) Safety Screen Vent Assembly, P/N: SHCK-SSVA-2x2
- (1) Suction Hose, P/N: PH-2x50
- (1) Johnson Screen Strainer, P/N: SHCK-JS-2x6

Tri Nuclear Corp.			
P.O. Box 1130, Ballston Lake, NY 12019			
UD-30A System Modes of Operation			
Model No. UD-30A	Dwg. TNC-011-02	Rev. D	Page 3 of 3